

EC Declaration of Conformity

We

GOOD WILL INSTRUMENT CO., LTD.

(1) No. 95-11, Pao-Chung Rd., Hsin-Tien City, Taipei Hsien, Taiwan

(2) Plot 522, Lorong Perusahaan Baru 3, Prai Industrial Estate, 13600 Prai, Penang, Malaysia

declares that the below mentioned product

GOS-6031, GOS-6030

are herewith confirmed to comply with the requirements set out in the Council Directive on the approximation of the law of Member States relating to Electromagnetic Compatibility (89/336/EEC, 92/31/EEC, 93/68/EEC) and Low Voltage Equipment Directive (72/23/EEC). For the evaluation regarding the Electromagnetic Compatibility and Low Voltage Equipment Directive, the following standards were applied:

EMC Directive 89/366/EEC amended by 92/31/EEC; 93/68/EEC

(EMI) EN 50081-1

EN 55022(1998)
EN 61000-3-2+A12(1996)
EN 61000-3-3(1995)

(EMS) EN 50082-1 : (1997)

EN 61000-4-2(1995)
EN 61000-4-3(1996)
EN 61000-4-4(1995)
EN 61000-4-5(1995)
EN 61000-4-6(1996)
EN 61000-4-8(1993)
EN 61000-4-11(1994)

(EMS) EN 61326 : (1998)

IEC 1000-4-2 (1995)
IEC 1000-4-3 (1995)
IEC 1000-4-4 (1995)
IEC 1000-4-5 (1995)
IEC 1000-4-6 (1996)
IEC 1000-4-11 (1994)

Low Voltage Equipment Directive 73/23/EEC & amended by 93/68/EEC

Safety Requirements
EN 61010-1: 1993+A2:1995

CONTENTS	PAGE
1. PRODUCT INTRODUCTION.....	1
1-1.Description.....	1
1-2.Feature.....	2
2. TECHNICAL SPECIFICATIONS.....	4
3. PRECAUTIONS BEFORE OPERATION.....	7
3-1.Unpacking the Oscilloscope.....	7
3-2.Checking the Line Voltage.....	7
3-3.Environment.....	8
3-4.Equipment Installation and Operation.....	8
3-5.CRT Intensity.....	8
3-6.Withstanding Voltage of Input Terminals.....	8
4. PANEL INTRODUCTION.....	8
4-1.Front Panel.....	11
4-2.Rear Panel.....	26
5. OPERATION METHOD.....	28
5-1.Readout Display.....	28
5-2.Connecting Input Signals.....	30
5-3.Adjustment and Checks.....	31
5-4.Function Check.....	33
5-5.Basic Operation.....	35
5-6.Measurement Application.....	44
6. MAINTENANCE.....	46
6-1.Fuse Replacement.....	46
6-2.Line Voltage Conversion.....	46
6-3.Cleaning.....	47
7. BLOCK DIAGRAM.....	48

SAFETY TERMS AND SYMBOLS

These terms may appear in this manual or on the product:



WARNING. Warning statements identify condition or practices that could result in injury or loss of life.



CAUTION. Caution statements identify conditions or practices that could result in damage to this product or other property.

The following symbols may appear in this manual or on the product:



DANGER
High Voltage



ATTENTION
refer to Manual



Protective
Conductor
Terminal



Earth(ground)
Terminal

FOR UNITED KINGDOM ONLY

NOTE: This lead/appliance must only be wired by competent persons

WARNING: THIS APPLIANCE MUST BE EARTHED

IMPORTANT: The wires in this lead are coloured in accordance with the following code:

Green/ Yellow:	Earth
Blue:	Neutral
Brown:	Live (Phase)

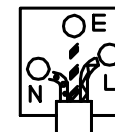

As the colours of the wires in main leads may not correspond with the colours marking identified in your plug/appliance, proceed as follows:

The wire which is coloured Green & Yellow must be connected to the Earth terminal marked with the letter E or by the earth symbol  or coloured Green or Green & Yellow.

The wire which is coloured Blue must be connected to the terminal which is marked with the letter N or coloured Blue or Black.

The wire which is coloured Brown must be connected to the terminal marked with the letter L or P or coloured Brown or Red.

If in doubt, consult the instructions provided with the equipment or contact the supplier.

This cable/appliance should be protected by a suitably rated and approved HBC mains fuse: refer to the rating information on the equipment and/or user instructions for details. As a guide, cable of 0.75mm² should be protected by a 3A or 5A fuse. Larger conductors would normally require 13A types, depending on the connection method used.

Any moulded mains connector that requires removal /replacement must be destroyed by removal of any fuse & fuse carrier and disposed of immediately, as a plug with bared wires is hazardous if engaged in live socket. Any re-wiring must be carried out in accordance with the information detailed on this label.

1.PRODUCT INTRODUCTION

1-1. Description

The GOS-6051/50/31/30 series are 50MHz/30MHz, two-channel, portable oscilloscopes for general purpose use. A microprocessor-based operating system controls most of the functions of the instrument, including cursor readout and digitized panel setting. On-screen alphanumeric readout and cursor function for voltage, time and frequency measurement provide extraordinary operational convenience. It also has the function of auto measurement for frequency and counter. Ten different user defined instrument settings can be saved and recalled without restriction.

The vertical deflection system has two input channels. Each channel has 14 basic deflection factors from 1mV to 20V per division. The horizontal deflection system provides sweep time from 0.5s to 0.2 μ s per division. The trigger system provides stable triggering over the full bandwidth of the vertical deflection system.

1-2.Features

Additionally, the oscilloscope offers several other features:

1) High intensity and internal graticule CRT

The oscilloscope employs a high intensity 6-inch rectangular type cathode-ray tube with red internal graticule. It displays clear readable traces even at high sweep speeds. Internal graticule lines eliminate parallax-viewing error between the trace and the graticule line.

2) Frequency Counter (GOS-6051/6031)

A built-in 6 digits frequency counter is accurate within the range of $\pm 0.01\%$ measuring frequency between 1kHz to 30/50MHz and $\pm 0.05\%$ measuring 50Hz to 1kHz.

3) ALT-MAG Function

The primary sweep waveform along with the magnified sweep waveform can be displayed simultaneously using the ALT-MAG function. The magnification ratio can be selected from among three stages of $\times 5$, $\times 10$, $\times 20$ for magnifying the displayed waveform in the center of the CRT.

4) Convenient VERT-MODE Triggering

The sync signal source is decided automatically when vertical axis mode is switched. This means that you need not change the trigger source every time you switch the VERT-MODE.

5) TV triggering

Exclusive TV sync separator circuit technology provides stable TV signal measurements on fields, frames and lines.

6) Hold Off

The function allows the obtaining of stable synchronization for even complex waveforms that are difficult to synchronized by adjusting the trigger level alone.

7) CH1 Signal Output

The CH1 signal output is obtained by branching the input signal in the middle of the signal line. As the connector outputs the input signal at a rate of 50mV/div, connecting a frequency counter makes it possible to measure the frequency of a very low signal while observing its waveform.

8) Z-axis intensity modulation

For applying a blanking signal from an external source. The trace displayed on the screen may be intensity-modulated where pulse signal or time-scale marks are required.

9) LED indicator and buzzer alarm

The LED's located in the front panel assist operation and indicated additional information. Incorrect operation and the electrical end position of control knobs are indicated by a warning beep.

10) SMD manufacturing technology

The instrument is built by using the most advanced SMD technology so as to reduce the number of internal wiring and shorten the foil route on the pc board. This will also greatly increase the high frequency performance and the reliability of the product.

11) Compact size (275Wx130Hx370D)mm and front panel layout groups for easy-to-use.

2. TECHNICAL SPECIFICATIONS

CRT	Type	6-inch rectangular type with internal graticule; 0%, 10%, 90% and 100% markers. 8 x 10 DIV (1 DIV = 1 cm)		
	Accelerating Potential	Approx. 10kV (GOS-6051/6050), 2kV (GOS-6031/6030)		
	INTEN and FOCUS	Front panel control.		
	Illumination	Provided (GOS-6051/6031)		
	Trace Rotation	Provided.		
Z-axis Input	Sensitivity: at least 5V Polarity : positive going input decrease intensity Usable frequency range: DC to 2MHz. Max. input voltage: 30V (DC +AC peak) at 1kHz or less. Input Impedance: approx. 33k Ω (GOS-6051/6050) 47k Ω (GOS-6031/6030)			
VERTICAL SYSTEM	Sensitivity Accuracy	1mV~2mV/DIV \pm 5%, 5mV~20V/DIV \pm 3%, 14 calibrated steps in 1-2-5 sequence.		
	Vernier Vertical Sensitivity	Continuously variable to 1/2.5 or less of panel indicate value.		
	Bandwidth(-3dB) and Rise Time	GOS-6051/6050	Bandwidth(-3dB)	Rise Time
		5mV~20V/DIV	DC~50MHz	Approx. 7ns
		1mV~2mV/DIV	DC~7MHz	Approx. 50ns
		GOS-6031/6030	Bandwidth(-3dB)	Rise Time
	5mV~20V/DIV	DC~30MHz	Approx. 11.7ns	
	1mV~2mV/DIV	DC~7MHz	Approx. 50ns	
	Maximum Input Voltage	400V (DC + AC peak) at 1kHz or less.		
	Input Coupling	AC, DC, GND		
Input Impedance	Approx. 1M Ω \pm 2% // approx. 25pF			
Vertical Modes	CH1, CH2, DUAL(CHOP/ALT), ADD, CH2 INV.			
CHOP Frequency	Approx. 250kHz.			
Dynamic Range	GOS-6051/6050: 6DIV at 50MHz, GOS-6031/6030: 8DIV at 20MHz, 6DIV at 30MHz			

HORIZONTAL SYSTEM	Sweep Time	0.2 μ s/DIV~0.5s/div, 20 steps selectable in 1-2-5 sequence, continuous variable control between steps at least 1:2.5.			
	Accuracy	$\pm 3\%$, $\pm 5\%$ at $\times 5$ and $\times 10$ MAG, $\pm 8\%$ at $\times 20$ MAG			
	Sweep Magnification	$\times 5$, $\times 10$, $\times 20$ MAG			
	Maximum Sweep Time (at MAG)	GOS-6051/6050:20ns/DIV(10ns/DIV uncalibrated) GOS-6031/6030:50ns/DIV(10ns/DIV~40ns/DIV uncalibrated).			
	ALT-MAG Function	Available.			
TRIGGER SYSTEM	Trigger Modes	AUTO, NORM, TV			
	Trigger Source	VERT-MODE, CH1, CH2, LINE, EXT.			
	Trigger Coupling	AC, HFR, LFR, TV-V(-), TV-H(-).			
	Trigger Slope	“+” or “-” polarity.			
	Trigger Sensitivity	GOS-6051/ GOS-6050	CH1, CH2	VERT- MODE	EXT
		20Hz~5MHz	0.5 DIV	2.0 DIV	200mV
		5MHz~40MHz	1.5 DIV	3.0 DIV	800mV
		40MHz~50MHz	2.0 DIV	3.5 DIV	1V
		GOS-6031/ GOS-6030	CH1, CH2	VERT- MODE	EXT
		20Hz~2MHz	0.5 DIV	2.0 DIV	200mV
2MHz~20MHz		1.5 DIV	3.0 DIV	800mV	
20MHz~30MHz		2.0 DIV	3.5 DIV	1V	
	TV sync pulse more than 1 DIV (CH1, CH2, VERT-MODE) or 200mV (EXT).				
External Trigger Input	Input impedance: Approx. 1M Ω //25pF(AC coupling) Max. input voltage: 400V (DC + AC peak) at 1kHz.				
Hold-off Time	Variable.				
X-Y OPERATION	Input	X-axis : CH1, Y-axis : CH2			
	Sensitivity	1mV/DIV~20V/DIV.			
	Bandwidth	X-axis: DC~500kHz (-3dB)			
	Phase Difference	3° or less from DC to 50kHz			
OUTPUT SIGNAL	CH1 Signal Output	Voltage : approx. 20mV/DIV (with 50 Ω terminal.) Bandwidth: 50Hz to at least 5MHz.			
	Calibrator output	Voltage : 0.5V $\pm 3\%$, Frequency: approx. 1kHz, square wave.			

CRT READOUT	Panel Setting Display	CH1/CH2 sensitivity, sweep time, trigger condition
	Panel Setting Save & Recall	10 sets.(GOS-6051/6031)
	Cursor Measurement (GOS-6051/6031)	Cursor Measurement Function: ΔV , ΔT , $1/\Delta T$. Cursor Resolution: 1/25 DIV. Effective Cursor Range: Vertical: ± 3 DIV, Horizontal: ± 4 DIV
Frequency Counter (GOS-6051/6031)	Display Digits: Max. 6-digits decimal. Frequency Range: 50Hz~50MHz (GOS-6051) 50Hz~30MHz (GOS-6031) Accuracy: $\pm 0.05\%$: 50Hz~1kHz. $\pm 0.01\%$: 1kHz~30/50MHz. Measuring Sensitivity: more than 2 DIV (measuring source selected from CH1 or CH2 as synchronous signal source).	
LINE POWER REQUIREMENT	Voltage	AC100V, 120V, 230V $\pm 10\%$ selectable.
	Frequency	50Hz or 60Hz.
	Power Consumption	Approx. 60VA, 50W(max).
MECHANICAL SPEC.	Dimensions	275(W) \times 130(H) \times 370(D) mm.
	Weights	8 kg
OPERATING ENVIRONMENT	Indoor use Altitude up to 2000 m Ambient temperature : To satisfy specifications : 10°C to 35°C (50° F to 95° F) Maximum operating ranges: 0°C to 40°C (32° F to 104° F) Relative humidity: 85% RH(max.) non condensing Installation Category : II Pollution degree 2	
STORAGE TEMPERATURE & HUMIDITY	-10° to 70°C, 70%RH(maximum)	
ACCESSORIES	Power cord.....	1
	Instruction manual.....	1
	Probe ($\times 1/\times 10$).....	2

3. PRECAUTIONS BEFORE OPERATION

3-1. Unpacking the Oscilloscope

The product has been fully inspected and tested before shipping from the factory. Upon receiving the instrument, please unpack and inspect it to check if there is any damages caused during transportation. If any sign of damage is found, notify the bearer and/or the dealer immediately.

3-2. Checking the Line Voltage

The oscilloscope can be applied any kind of line voltage shown in the table below. Before connecting the power plug to an AC line outlet, make sure the voltage selector of the rear panel is set to the correct position corresponding to the line voltage. It might be damaged the instrument if connected to the wrong AC line voltage.



WARNING. To avoid electrical shock the power cord protective grounding conductor must be connected to ground.

When line voltages are changed, replace the required fuses shown as below:

Line voltage	Range	Fuse	Line voltage	Range	Fuse
100V 120V	90-110V 108-132V	T 1A250V	230V	207-250V	T 0.4A250V



WARNING. To avoid personal injury, disconnect the power cord before removing the fuse holder.

3-3. Environment

The normal ambient temperature range of this instrument is from 0° to 40°C (32° to 104°F). To operate the instrument over this specific temperature range may cause damage to the circuits.

Do not use the instrument in a place where strong magnetic or electric field exists as it may disturb the measurement.

3-4. Equipment Installation, and Operation

Ensure there is proper ventilation for the vents in the oscilloscope case. If the equipment is used not according to the specification, the protection provided by the equipment may be impaired.

3-5. CRT Intensity

To prevent permanent damage to the CRT phosphor, do not make the CRT trace brighten excessively or leave the spot stay for an unreasonably long time.

3-6. Withstanding Voltages of Input Terminals

The withstanding voltages of the instrument input terminals and probe Input terminals are shown in the following table. Do not apply voltages higher than these limits.

Input terminal	Maximum input voltage
CH1, CH2, inputs	400V (DC + AC peak)
EXT TRIG input	400V (DC + AC peak)
Probe inputs	600V (DC + AC peak)
Z AXIS input	30V (DC + AC peak)



CAUTION. To avoid damaging the instrument, do not apply input voltages of the frequency over 1 kHz to the instrument.

4. PANEL INTRODUCTION

After the instrument is switched on, all the important settings are displayed in the readout. The LED's located on the front panel assist operation and indicate additional information. Incorrect operation and the electrical end positions of control knobs are indicated by a warning beep.

All of the pushbuttons, VOLTS/DIV control knobs, TIME/DIV control knobs are electronically selected, and their functions and settings can therefore be stored.

The front panel is subdivided into four sections:

- Display controls
- Vertical controls
- Horizontal controls
- Trigger controls

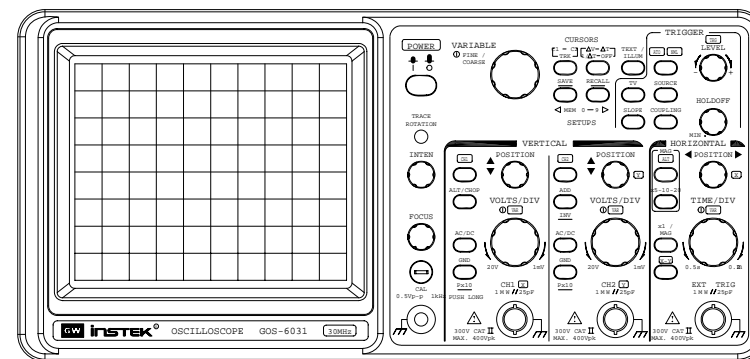

Front panel of GOS-6031/6051

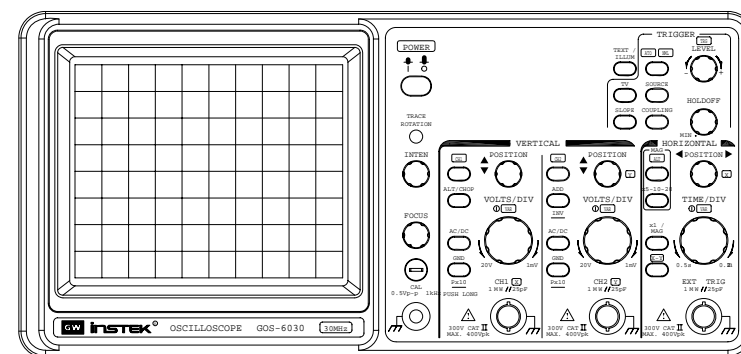

Front panel of GOS-6030/6050

4-1. Front Panel

Display controls

The display controls adjust the on-screen appearance of the waveform and provide a probe compensation signal source.

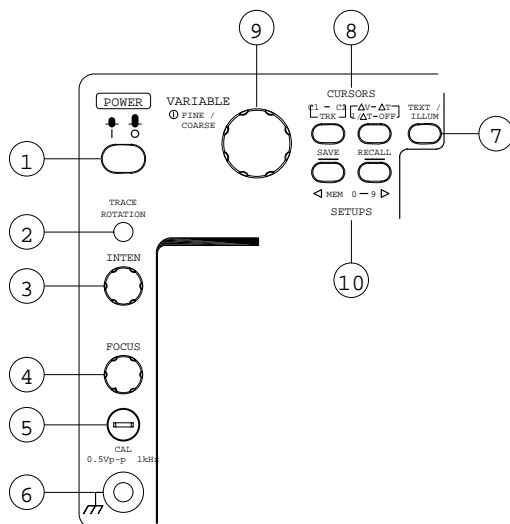

(1) POWER – Pushbutton

When switch on the oscilloscope to have all LEDs lighted and wait a few seconds, the normal operation mode is present. Then the last settings become activated and the LED indicates “ON” condition.

(2) TRACE ROTATION

The TRACE ROTATION is for aligning the horizontal trace in parallel with graticule lines. This potentiometer can be adjusted with a small screwdriver.

(3) INTEN—Control knob

The control knob is used for adjusting the traces intensity. Turning the knob clockwise to increase the intensity while turning it counterclockwise to decrease the intensity.

(4) FOCUS

The control knob effects both the trace and the readout sharply.

(5) CAL

The terminal provides a reference signal of 0.5Vp-p at 1kHz for probe adjustment.

(6) Ground Socket—Banana Socket galvanically connected to safety earth

This socket can be used a reference potential connection for DC and low frequency signal measurement purpose.

(7) TEXT/ILLUM—Control knob with a double function.

The pushbutton is for selecting the text readout intensity function or scale illumination function, and indicates the letter “TEXT” or “ILLUM” in the readout. Press the pushbutton for the following sequences:

“TEXT” — “ILLUM” — “TEXT”

The TEXT/ILLUM function are associated the VARIABLE(9) control knob. Turning the knob clockwise to increase the text intensity or scale illumination, while turning the knob counterclockwise to decrease it. Pressing the knob to switch the TEXT/ILLUM on or off.

(8) CURSORS MEASUREMENT FUNCTION (GOS-6051/6031)

There are two pushbutton and associated the VARIABLE(9) control knob.

ΔV — ΔT — $1/\Delta T$ —OFF Pushbutton

When the pushbutton is pressed, the three measurement functions will be selected in the sequence as follows:

ΔV : Two horizontal cursors appear. The voltage between the two cursors is calculated according to the setting of VOLTS/DIV, and displayed with ΔV on the upper side of the CRT.

ΔT : Two vertical cursors appear. The time between the two cursors is calculated according to the setting of TIME/DIV, and displayed with ΔT on the upper side of the CRT.

$1/\Delta T$: Two vertical cursors appear. The reciprocal of the time (frequency) between the two cursors is calculated with $1/\Delta T$ on the upper side of the CRT.

C1—C2—TRK Pushbutton

The cursor 1, cursor 2 and tracking can be selected by this button. Pressing the pushbutton to select the cursors in sequence as follows:

C1: Moves the cursor 1 on the CRT(▼ or ► symbol is displayed)

C2: Moves the cursor 2 on the CRT(▼ or ► symbol is displayed)

TRK: Simultaneously moves the cursor 1 and cursor 2 with the interval between the two cursors unchanged (both symbol are displayed at the two cursors.)

(9) **VARIABLE**—

Set the cursor position, TEXT/ILLUM, etc. by turning or pressing the VARIABLE knob.

In the cursor mode, pressing the VARIABLE control knob to select the cursor position between FINE and COARSE adjustment. When select FINE adjustment by turning the VARIABLE, the cursor lines will move slowly. If select COARSE adjustment, he cursor will move fast.

In TEXT/ILLUM mode, this control knob can be used to set the text intensity or illumination. Please refer to TXT/ILLUM(7) for details.

(10). ◀ **MEMO-9** ▶ —SAVE/RECALL(GOS-6051/6031)

The instrument contains 10 non-volatile memories, which can be used by the operator to save instrument setting and to recall them. It relates to all controls which are electronically selected.

Press ◀ or ▶ pushbutton to select the memory location. The readout then indicates the letter “M” followed by a cipher between 0 and 9. Each time the ▶ pushbutton is briefly pressed the memory location cipher increases until the number 9 is reached. The ◀ pushbutton is similar but decreases the memory location cipher until the number 0 is reached.

Pressing and holding SAVE for approx. 3 seconds to write the instrument settings in the memory and indicate the associated readout information of “◀ ”.

To recall a front panel setup, select a memory location as described above. Recall the settings by pressing and holding the RECALL pushbutton for approx. 3 seconds, the readout then indicates the associated readout information of “▶ ”.

Vertical controls

The vertical controls select the displayed signals and control the amplitude characteristics.

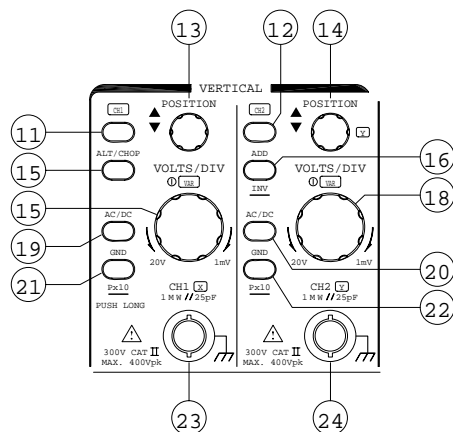

(11) **CH1**—Pushbutton

(12) **CH2**—Pushbutton

Pressing briefly the CH1 (CH2) button to set the channel 1 (channel 2) of the instrument on, the deflection coefficient will be displayed in the readout indicating the current conditions.

(13) **CH1 POSITION**—Control knob

(14) **CH2 POSITION**—Control knob

The vertical trace position of channel 1 (channel 2) can be set with the control knob.

In X-Y mode, CH2 POSITION control knob is used for the Y deflection.

(15) **ALT/CHOP**

The pushbutton has two functions, which are required and available only when both channels are active.

ALT—Displays in the readout, indicates alternate channel switching. After each time base sweeps the instrument internally, switches over from channel 1 and channel 2 and vice versa.

CHOP—Indicates chopper

The channel switching occurs constantly between channel 1 and channel 2 during each sweep.

(16) **ADD-INV**—Pushbutton with double functions.

ADD— Displays the “+” symbol in the readout, indicates additional mode.

Whether the algebraic sum (addition) or the difference (subtraction) of both input signals is displayed, depends on the phase relationship and the INV setting. As a result, both signals are displayed as one signal. For correct measurements, the deflection coefficients for both channels must be equal.

INV—Pressing and holding the pushbutton to set the channel 2 invert function on or off. The invert on condition is indicated by the “ ∇ ” symbol in the readout. The invert function causes the signal display of channel 2 to be inverted by 180°.

(17) **CH1 VOLTS/DIV**

(18) **CH2 VOLTS/DIV**— Control knob for channel 1/channel 2 has double functions.

Turning the knob clockwise to increase the sensitivity in 1-2-5 sequence and turning it in the opposite direction (CCW) to decrease. The available range is from 1mV/div up to 20V/div. The knob is automatically switched inactive if the related channel is switched off.

The deflection coefficients and additional information regarding the active channels are displayed in the readout.

VAR

Pressing the VOLTS/DIV control knob to select the VOLTS/DIV function between attenuator and vernier (variable). The current setting is displayed by the “>” symbol in the readout.

After switching on the VAR, turn the VOLTS/DIV control knob counterclockwise to reduce the signal height, and the deflection coefficient becomes uncalibrated.

(19)CH1 AC/DC**(20)CH2 AC/DC**

Pressing the pushbutton briefly to switch over from AC (~ symbol) to DC (= symbol) input coupling. The setting is displayed in the readout with the deflection coefficient.

(21)CH1 GND– P×10**(22)CH2 GND – P×10 –Pushbutton of two functions.****GND**

Each time when the pushbutton is pressed briefly, the input of the vertical amplifier is grounded. It is displayed in the readout as an earth (ground) symbol “”.

P×10

Pressing and holding the pushbutton to select the indicated deflection coefficient of the channel displayed in the readout between 1:1 and 10:1. The probe factor of 10:1 is displayed in the readout with the probe symbol “P×10” in front of channel indication. When proceed cursor voltage measurement, the probe factor will be automatically included. The symbol must not be activated unless a 10:1 attenuator probes are used.

(23)CH1-X—Input BNC socket

This BNC socket is the signal input for channel 1. In X-Y mode, signals at this input are used for the X deflection. The outer (ground) connection is galvanically connected to the instrument ground and consequently to the safety earth contact of the line/mains plug.

(24)CH2-Y—Input BNC socket

This BNC socket is the signal input for channel 2. In X-Y mode, signals at this input are used for the Y deflection. The outer (ground) connection is galvanically connected to the instrument ground and consequently to the safety earth contact of the line/mains plug.

Horizontal controls:

The horizontal controls select the time base operation mode and adjust the horizontal scale, position and magnification of the signal.

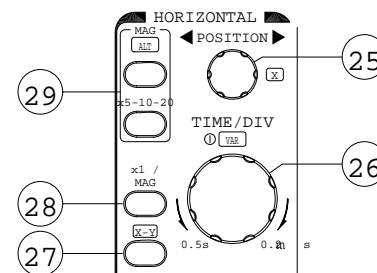

(25)H POSITION

The control knob enables a horizontal position shift of the signals. In combination with MAG the function makes it possible to shift any part of the signal on the screen.

In X-Y mode, the control knob are used for the X deflection.

(26)TIME/DIV-VAR– Control knobs

Turning the knob clockwise to reduce the deflection coefficient in a 1-2-5 sequence and turning it in the opposite direction (CCW) to increase. The time coefficient(s) will be displayed in the readout.

The time deflection coefficients between 0.5s/div and 0.2 μ s/div can be chosen in 1-2-5 sequence, if the MAG function is not activated.

VAR

Pressing the pushbutton to select the TIME/DIV control knob function between time base switch and vernier (variable). After switching on the VAR, the time deflection coefficient is still calibrated until further adjustments are made. Turn the TIME/DIV control knob counter clockwise to increase the time deflection coefficient (reduce the deflection speed) and the deflection coefficient becomes uncalibrated. The current setting is displayed by the “>” symbol in the readout.

(27)X-Y

Pressing the pushbutton when using the instrument as an X-Y oscilloscope. The time deflection coefficient is replaced by the “X-Y” symbol in the readout.

In this mode, the X (horizontal) signal is connected to the input of CH1; the Y (vertical) signal is applied to the input of CH2 and has a deflection range from less than 1mV to 20V/div at a reduced band-width of 500kHz.

(28)x1/MAG

Pressing the pushbutton the select the sweep time between $\times 1$ (normal) and MAG (magnify). If the MAG function, the signal display will be expanded and consequently only a part of the signal curve is visible. The interesting part of the signal can be made visible with the aid of the H POSITION control.

(29)MAG FUNCTION **$\times 5$ - $\times 10$ - $\times 20$ MAG**

When MAG has been done, the displayed waveform will be expanded to the right and left with the center of the CRT. The magnification ratio can be selected from among three stage of $\times 5$ - $\times 10$ - $\times 20$ MAG by pressing this pushbutton.

ALT MAG

Pressing the pushbutton, the primary sweep waveform along with the magnified sweep waveform. The magnified can be displayed simultaneously using the ALT-MAG function. The magnified sweep waveform appears 3 divisions below the primary sweep waveform.

Trigger controls

The trigger controls determine the sweep start timing for both signal.

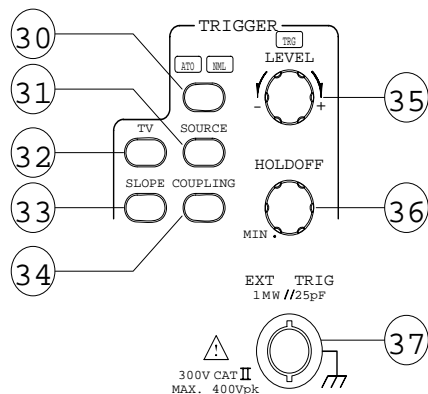

(30) ATO/NML – Pushbutton and indicator LEDs.

Pressing the pushbutton to select auto or normal trigger mode. The actual setting is indicated by a LED.

Each time when the pushbutton is pressed the trigger mode changes in the sequence:

ATO—NML—ATO

ATO (Auto)

Select the automatical mode, the sweep free-runs will display a baseline trace when there is no trigger signal. The setting of triggering level changed only when the TRIGGER LEVEL control is adjusted to a new level setting.

NML (Normal)

Select the normal mode, the input signal will trigger the sweep when the TRIGGER LEVEL control is set within the peak-to-peak limits of

an adequate trigger signal. When the sweep is not triggered, no baseline trace will be displayed.

Use this mode when effecting synchronization to a very low frequency signal (25Hz or less).

(31) SOURCE—Pushbutton

Pressing the pushbutton to select the trigger signal source. The actual setting is indicated by the readout (“SOURCE”, slope, coupling).

Each time when the pushbutton is pressed, the trigger source change in the sequence:

VERT—CH1—CH2—LINE—EXT—VERT

VERT (Vertical Mode)

For observing two waveforms, the sync signal changes alternately corresponding to the signals on CH1 and CH2 to trigger the signal.

CH1

The signal applied to the channel 1 input connector is the source of the trigger signal.

CH2

The signal applied to the channel 2 input connector is the source of the trigger signal.

LINE

The triggering signal is obtained from a sample of the AC power source waveform. The trigger source is useful when the displayed waveform frequency is time related to the AC power source frequency.

EXT

The external signal applied through the EXT input connector is used for the external triggering source signal.

(32)TV—Pushbutton for video sync signal selection

Separate the video sync signal from the composite waveform and direct it to the triggering circuit. The horizontal or vertical sync signals are selected by TV pushbutton. The current setting is displayed in the readout under item (source, video polarity, “TVV or TVH”). Each time when the pushbutton is pressed, the video sync signal is displayed in the sequences as follows:

TV-V—TV-H—OFF—TV-V

TV-V

Start the main trace at the beginning of a video signal field. The polarity must match the composite sync polarity (i.e., “” for negative sync) to obtain TV field triggering on the vertical sync pulse.

TV-H

Start the main trace at the beginning of a video signal line. The polarity must match the composite sync polarity to obtain TV line triggering on the horizontal sync pulse.

(33)SLOPE—Pushbutton for the triggering slope.

Briefly pressing the pushbutton to select the slope of the signal which is used for triggering the time base generator. Each time when the pushbutton is briefly pressed, the slope direction will switch from falling edge to rising edge, and vice versa.

The current setting is displayed in the readout under item “source, SLOPE, coupling”.

If in the TV trigger mode, it is synchronized only when the sync signal is negative. A “” symbol is displayed in the readout.

(34)COUPLING—

Pressing the pushbutton to select the trigger coupling. The actual setting is indicated by the readout (source, slope “COUPLING”).

Each time when the COUPLING pushbutton is pressed the trigger coupling changes in the sequence:

AC—HFR—LFR—AC

AC

Attenuates trigger signal frequency components below 20Hz and blocks the DC component of the signal.

AC coupling is useful for triggering on AC waveforms that have a large DC offset.

HFR (High Frequency Reject)

Attenuates high-frequency triggering signal components above 50kHz. HFR coupling is useful for providing a stable display of low-frequency components of complex waveforms and eliminates high-frequency interference from the trigger signal.

LFR (Low Frequency Reject)

Attenuates low-frequency triggering signal components below 30kHz and blocks the DC component of the trigger signal.

LFR coupling is useful for producing stable triggering on the high-frequency components of complex waveforms and rejecting low-frequency interference or power supply hum from the trigger signal.

(35)TRIGGER LEVEL—Control knob with TRG LED

Turning the control knob causes a different trigger input setting (voltage), and set to a suitable position for the starting of triggered sweep of the waveform. When rotate clockwise the control knob, the

trigger point moves toward the positive peak of the trigger signal and rotate it counterclockwise to move the trigger point toward the negative peak of the trigger signal.

When the setting (voltage) value is out of the changing portion of the observation waveform, the synchronization sweep stops.

TRG LED

The TRG LED is lit if the triggering conditions are met. Whether the LED flashes or is lit constantly depends on the frequency of the trigger signal.

(36)HOLD-OFF—Control knob

Used when the signal waveform is complex and stable triggering cannot be attained with the TRIGGER LEVEL(35) knob alone, rotate this control knob to adjust hold-off time(trigger inhibit period beyond sweep duration). When control is rotated fully clockwise, the hold-off period is at MINimum (normal). The hold-off period increases progressively with counterclockwise rotation.

(37)TRIG EXT—This BNC socket is the external trigger signal input.

Pressing the TRIG. SOURCE (31) pushbutton until the information of “EXT, slope, coupling” is shown up in the readout switches the input on.

The outer (ground) connection is galvanically connected to the instrument ground and consequently to the safety earth contact of the line/mains plug.

The maximum input voltages of the input terminal are shown in the section of 3-6. “Withstanding voltage of Input terminals”. Do not apply voltage higher than the limit.

4-2.Rear Panel

The rear panel provides input power and additional signal connections.

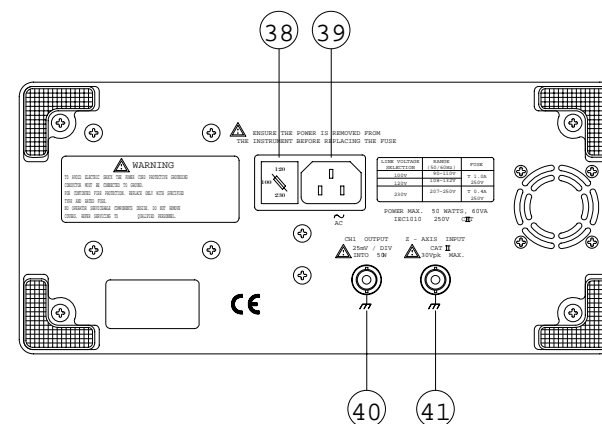

(38)Line voltage selector and input fuse holder—Select power source and contain the primary power fuse

The fuse rating is shown in the section of 3-2 Checking the line voltage.

(39)AC power input connector

Connect the AC power cord to the power supply of instrument, the power cord protective-ground connection is connected to the exposed metal part of the instrument. The power cord must be connected to a proper grounded source for electrical-shock protection.

(40)CH1 Output—BNC socket

This output may be used to connect to a frequency counter or other instrument.

(41)Z-Axis Input—BNC socket

Connect external signals to the Z-axis amplifier for intensity modulating the CRT display. This terminal is DC-coupled. The intensity is lowered by a positive signal, while it is increased by a negative signal.

5. OPERATION METHOD

This section contains basic operation information and techniques that should be considered before proceeding any measurement. As for the location and function of instrument controls, connectors, and indicators, refer to the “Instruction of Front Panel and Rear Panel” of this manual.

5-1.Readout Display

The CRT readout display indicates how to set up the instrument controls. No physical marking shown on the rotating switches indicates the control setting. A key to the location and type of readout information displayed is illustrated in figure 5-1:

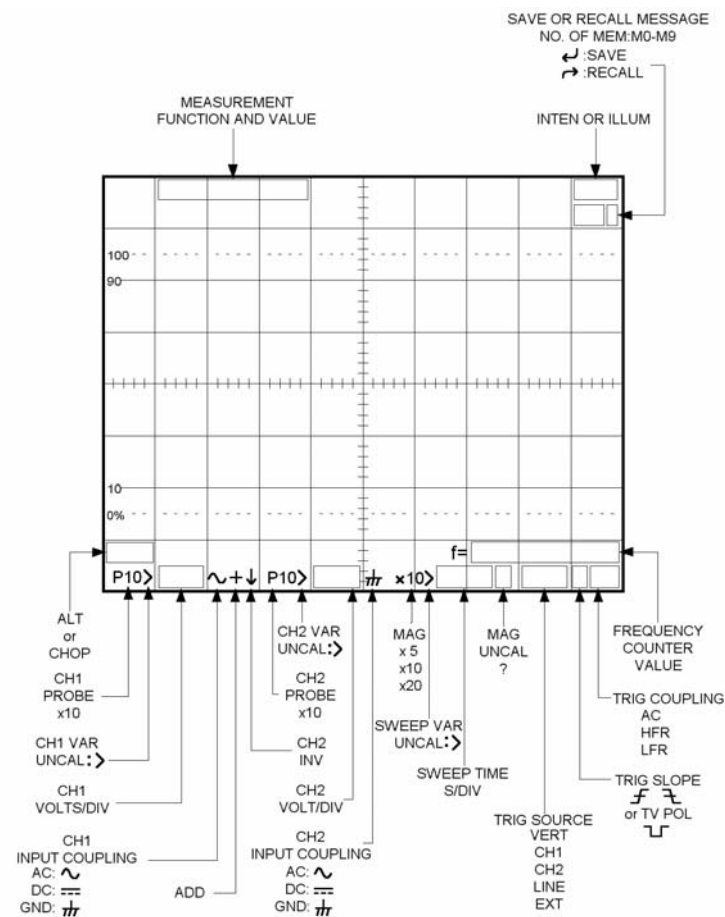

Figure 5-1 Readout Layout

5-2. Connecting Input Signals

Grounding

The most reliable signal measurements are made when the oscilloscope and the unit under test are connected by a common reference (ground lead) in addition to the signal lead or probe. The ground lead of the probe provides the best grounding method for signal interconnection and ensures the maximum amount of signal-lead shielding in the probe cable. A separate ground lead (with a banana plug) can also be connected from the unit under test to the oscilloscope ground jack on the front panel.

Probes

A probe provides the most convenient way to connect an input signal to the oscilloscope. The standard $\times 1/\times 10$ probes supplied to the oscilloscope are shielded against electromagnetic interference and have a high input impedance for low circuit loading.



CAUTION. To get the best waveform precisely, keep probe ground and signal leads as short as possible.

Misadjust probe compensation can cause measurement error. Check and adjust probe compensation whenever a probe is moved to a different channel or oscilloscope. As for the probe compensation adjustment procedure, refer to the “Probe Compensation”.

Coaxial Cables

Signal input cable can greatly affect the accuracy of a displayed waveform. To maintain original frequency characteristics of the input signal, use only high-quality, low-loss coaxial cables. Coaxial cables must be terminated at both ends in their characteristic impedance to prevent signal reflections within the cable. Use suitable impedance-matching devices.

5-3.Adjustments and checks

Trace Rotation Adjustment

Normally, when the trace is in parallel with the center horizontal graticule line, there will be no need to adjust the TRACE ROTATION. If necessary, adjust the TRACE ROTATION to make the baseline trace parallel to the center horizontal graticule line by using a small straight-blade screwdriver or alignment tool.

Probe Compensation

To minimize the distortion of measured waveforms, check the compensation of your probes before using them. The probe compensation should be checked periodically whenever the probes are moved to different input channels.

1. Install the probes onto the oscilloscope (Press the BNC connector onto the channel input and rotate the connector to lock it into place).
2. Set the probe slide switches to the $\times 10$ position.
3. Briefly pressing the CH1/CH2 button to set the oscilloscope to channel 1 and channel 2.
4. Pressing and holding the P $\times 10$ button to set the indicated deflection coefficient of the channel displayed in the readout as a symbol "P10".
5. Attach the probe tips to the CAL connection in the front of the oscilloscope.
6. Set the oscilloscope controls to display both channels:

VERTICAL:	VOLTS/DIV	0.2V
	COUPLING	DC
	ALT/CHOP	CHOP
HORIZONTAL:	TIME/DIV	0.5ms
TRIGGER:	MODE	ATO
	SOURCE	VERT
	COUPLING	AC
	SLOPE	$\overline{\text{⏏}}$

7. Observe the displayed waveform and compare them with the waveforms shown in figure 5-2. If either probe needs to be adjusted, proceed the step 8. If either probe does not need to be adjusted, proceed the "Function Check".

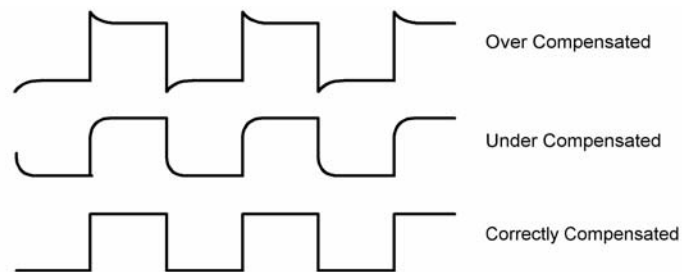

Figure 5-2 Typical Compensation Waveform

8. Adjust the probe by using a small insulated screwdriver. Slowly rotate the adjustment control until the probe is properly compensated.

5-4.Function Check

When you start to check the operation of your oscilloscope, proceed the following instruction:

1. Install the $\times 10$ probes onto CH1 and CH2 inputs.
2. Connect the probe tips to the CAL test point of the oscilloscope.
3. Set the oscilloscope controls to display both channels:

VERTICAL:	VOLTS/DIV	0.2V
	COUPLING	DC
	ALT/CHOP	CHOP
HORIZONTAL:	TIME/DIV	0.5ms
TRIGGER:	MODE	ATO
	SOURCE	VERT
	COUPLING	AC
	SLOPE	$\overline{\uparrow}$

The figure 5-3 below illustrates a satisfactory display. The waveform should be approximately 0.5Vp-p at a frequency of 1kHz that confirms the vertical and horizontal deflection function of the oscilloscope.

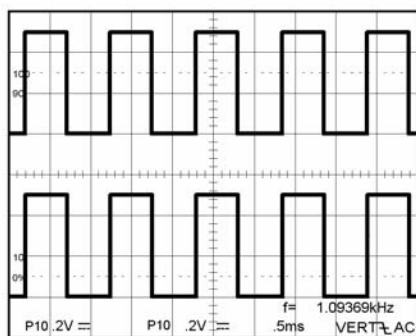

Figure 5-3

4. Set both CH1 and CH2 COUPLING to GND.
5. Use the CH1 and CH2 POSITION controls to align both traces on the center graticule.
6. Open the CH2 INV by pressing and holding the pushbutton.
7. Set to the ADD mode by pressing the ADD pushbutton briefly.
8. Set both CH1 and CH2 COUPLING to DC.
9. The figure 5-4 below shows a satisfactory display. The display will show a flat trace located on the center graticule that confirms the channel balance and ADD offset function.

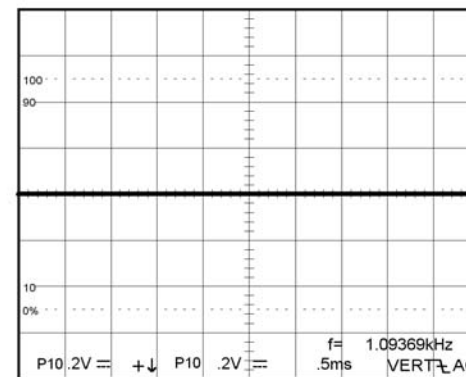

Figure 5-4 ADD mode

10. Turn off the ADD mode by pressing the ADD pushbutton briefly.
11. Turn off the CH2 INV by pressing and holding the pushbutton.

5-5. Basic Operation

Displaying CH1 or CH2

To display the signal from a signal channel, pressing briefly the CH1 or CH2 pushbutton to set the oscilloscope to channel 1 or channel 2.

Displaying CH1 and CH2

To display both signals at the same time, proceed the following steps:

1. Set the CH1 and CH2 on. The figure 5-5 below shows two synchronous waveforms in the both modes.
2. Adjust the CH1 or CH2 POSITION control to position the two waveforms.
3. Set the ALT/CHOP button to CHOP mode if the waveforms are flickering.

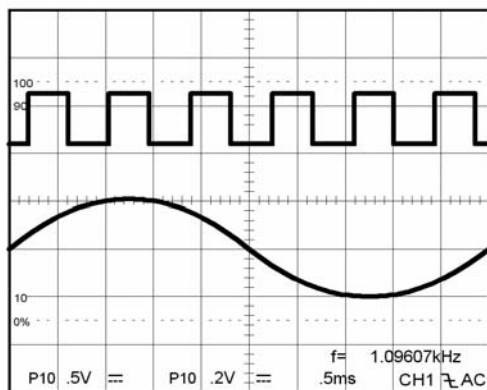

Figure 5-5 Both typical waveforms

Displaying the sum or difference of CH1 and CH2

To display the algebraic sum or difference of CH1 and CH2, proceed the following steps:

1. Set the ADD button to ADD mode. The figure 5-6 below shows the sum of the waveforms from figure 5-5.
2. Set the CH2 INV on by pressing and holding the button, if necessary, to display the different waveform.
3. Pressing and holding one of the VOLTS/DIV control knob to set it to vernier (variable). Then adjust one channel to the other in the event of gain difference.

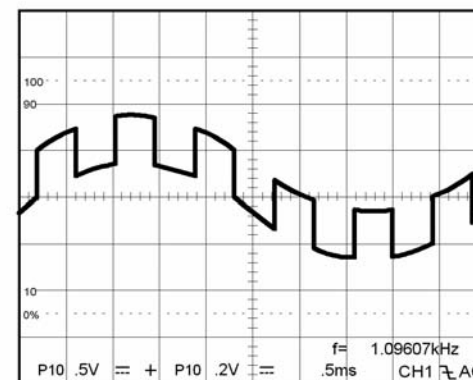

Figure 5-6 Typical ADD waveform

Comparing Frequency and phase (X-Y Operation)

To compare the frequency and phase between two signals by using the X-Y mode. The X-Y waveform displays different amplitude, frequency, and phase. The figure 5-7 shows a typical waveform made up of two signals that are of the same frequency and amplitude, but approximate 45° out of phase.

To use the oscilloscope in the X-Y mode, proceed the following steps:

1. Connect the horizontal or X-axis signal to the CH1 input.
2. Connect the vertical or Y-axis signal to the CH2 input.
3. Set the X-Y button to X-Y operation (shown as Fig. 5-7 below).

Use the HORIZONTAL POSITION control to adjust the X-axis.

Note: When high frequency signals are displayed in the X-Y operation, note the frequency bandwidths and phase difference between X and Y axis. Refer to “2. SPECIFICATION” section for details.

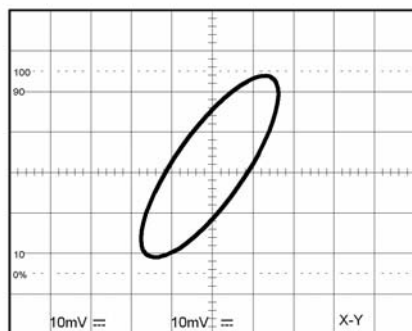

Figure 5-7 Typical single X-Y display.

Magnifying Waveform Events

Use the MAG pushbutton to view small portions of a waveform as which is too far back from the starting point to view by using the TIME/DIV control. To use the MAG button, proceed the following steps:

1. Adjust the TIME/DIV to the fastest sweep that displays the event.
2. Rotate the HORIZONTAL POSITION control to move the event to display on the center of screen.
3. Press the MAG button.
4. Select MAG $\times 5$, MAG $\times 10$, or MAG $\times 20$ for MAG function.

When above procedures have been done, the displayed waveform will be expanded 10 times to the right and left from the center of screen as center of expansion.

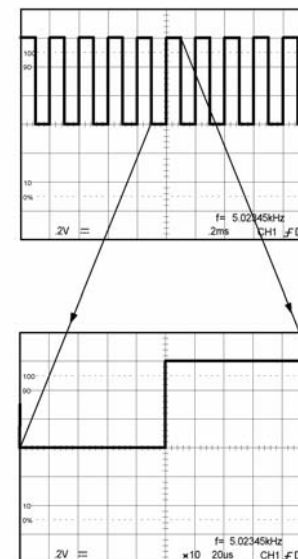

Figure 5-8 Magnified Waveform

MAG-ALT Function

The input Signal is displayed by pressing MAG(magnify) and MAG-ALT(LED light) buttons:

1. Set the wished portion of the waveform to the center of the screen for magnification.
2. The magnified waveform spreads about 3 divisions below the normal (x 1) waveform.
3. It is a normal function when the MAG-ALT button is pressed, the characters will be vanished from the screen.

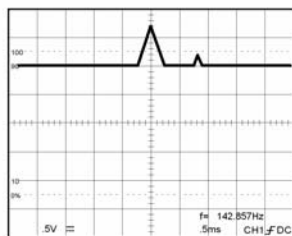

Figure 5-9(a) Mag.x1 Waveform

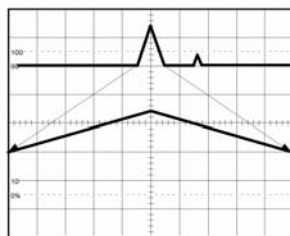

Figure 5-9(b) Mag.x10 Waveform

Operating Hold off time Control

When the measured signal is a complex waveform with two or more repetition frequencies (period), triggering with the LEVEL control alone may not be sufficient to attain a stable waveform display. In such a case, the sweep can be stable synchronized to the measured signal waveform by adjusting the Hold off time of the sweep waveform.

Figure 5-10(a) shows several different waveforms which overlapped on the screen, marking the signal observation unsuccessful when the hold off is set to minimum.

Figure 5-10(b) shows the undesirable portion of the signal is held off. The same waveforms are displayed on the screen without overlapping.

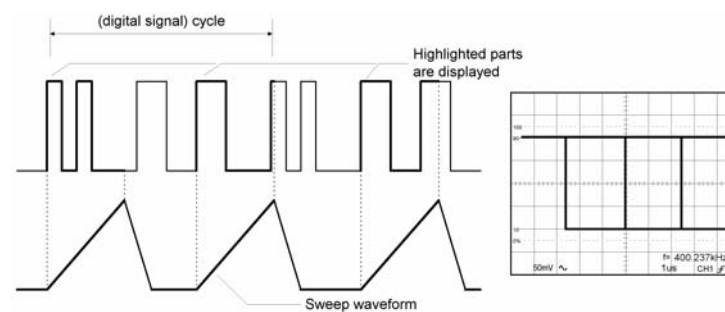

Figure 5-10(a)

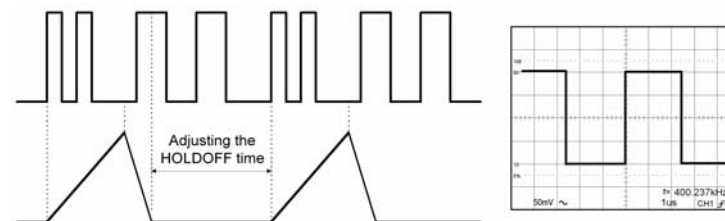

Figure 5-10(b)

Observing the Synchronization of two Waveforms

When two signals of the CH1 and CH2 have the same frequencies with an integral number, or a specific time difference, the SOURCE selects either CH1 or CH2 as a reference signal. Select CH1 signal from CH1 position and select CH2 signal from CH2 position as a reference.

Set the SOURCE to VERT-MODE for observing the signal of different frequencies. Switch the sync signal alternately to each channel, the waveform of each channel will be triggered stably.

When set the SOURCE to VERT-MODE and set the ALT/CHOP to ALT, the input signals applied to CH1 and CH2 will become trigger source alternately during sweep. Consequently, even the waveforms of different frequency of each channel can be triggered stably.

Apply a sine wave to CH1 and a square wave to CH2, "A"s shown in Figure 5-11 are at the level possible for synchronization.

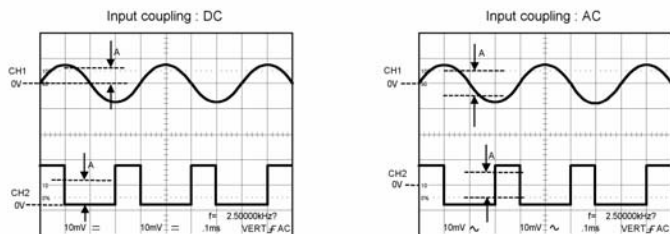

Figure 5-11 Trig. Source on VERT

Apply AC coupling to CH2 in order to expand the synchronization range. If the input signal of CH1 or CH2 becomes small, adjust VOLT/DIV control knob to obtain sufficient amplitude.

The VERT-MODE triggering required 2.0 div which is larger than the amplitude of CH1 or CH2.

The VERT-MODE triggering is not possible when the signal is applied only to one channel as shown in Figure 5-12 below:

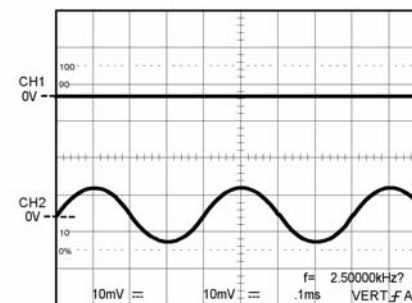

Figure 5-12 Trig. Source on VERT. one channel

ALTERNATE TRIGGER

The Jittering wave as shown in Figure may appear on the screen when a gently-sloping signal is displayed 10 cycles or less approximately by setting VERT-MODE to SOURCE, and setting ALT/CHOP pushbutton to ALT. For detailed and clear observation of each signal, set VERTICAL mode to CH1 or CH2.

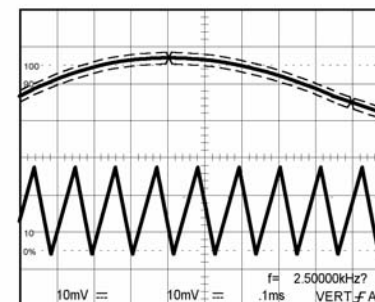

Figure 5-13 Alternate Trig.

Triggering of Video signal

In the work concerned with TV, complex signals and containing video signal, blanking pedestal signal, and synchronizing signal are often measured.

Press the TV pushbutton to set the TV position. The built-in active TV-Sync-separator provides the separation of frame or line sync pulses from the video signal. To trigger the oscilloscope at the vertical (frame) rate, press the TV pushbutton to set TV-V and TV-H triggering. The figure 5-14(a) shows vertical signal of TV-V and Figure 5-14(b) shows horizontal signal of TV-H.

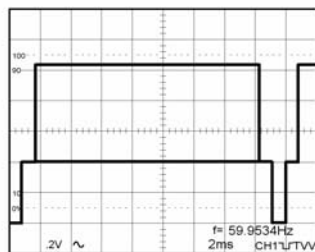

Figure 5-14(a) TV-V

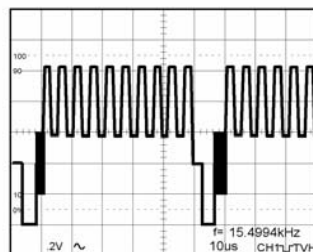

Figure 5-14(b) TV-H

The figure 5-15 shows the examples of TV polarity synchronization signals.

Note: This oscilloscope synchronizes with only (▭) synchronizing signal.

REFERENCE:

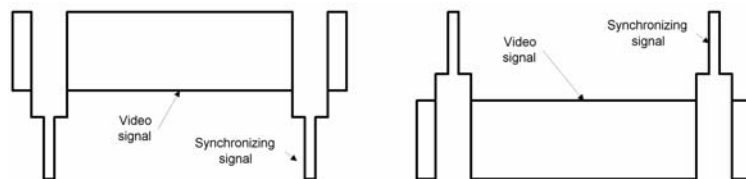

Figure 5-15 TV Signal

5-6.Measurement Application (GOS-6051/6031)

The oscilloscope has a cursor measurement system for making accurate, direct-readout voltage, time and frequency measurements. The measurements described in this section are examples of typical applications using this measurement system. After becoming familiar with the controls, indicators, and capabilities of the instrument, you can develop convenient methods to make the special measurement for your own applications.

Proceed a measurement by using the cursor according to the following steps:

1. Press the [$\Delta V - \Delta T, 1/\Delta T - OFF$] pushbuttons to turn on the cursor and measurement readout.

2. Press the pushbutton to select the seven measurement function in the sequence as below:

$\Delta V - \Delta T - 1/\Delta T - OFF$

3. Press the [C1—C2 TRK] pushbutton to select C1(▼) cursor, C2(▽) cursor and tracking cursor.

4. Rotate the VARIABLE control knob to position selected cursor. Press one of the VARIABLE control knob to select FINE or COARSE cursor move speed.

5. Read the measurement value on the screen. Typical measurement readouts and applications are shown in Figure 5-16. The measurement values are automatically controlled by the VOLTS/DIV and TIME/DIV control settings.

Figure 5-16: Cursor Measurement

(a). Typical ΔV (Voltage difference) for AC voltage.

When both CH1 and CH2 are turned on, the measurement value of CH1 ($\Delta V1$).

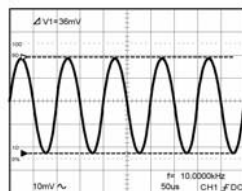

(b). Typical ΔT (Time difference) cursor measurement for rise time.

Proceed rise-time or fall-time measurement requiring some additional signal scaling by using the graticule rise-time measurement aids. Number 0%, 10, 90 and 100 are etched near the left vertical gratical line. Use the following steps as a guideline to in making rise-time measurement:

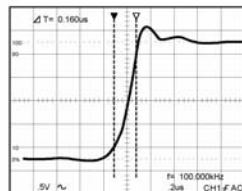

(c). Typical $1/\Delta T$ cursor function for frequency measurement.

When the two cursors are superimposed at two edge points of the one period waveform by the [C1—C2 TRK] and VARIABLE controls, the measurement value is displayed in frequency units on the upper side of the screen.

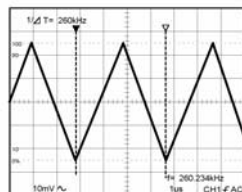

NOTE. When the VOLTS/DIV or the TIME/DIV controls are in uncalibrated setting, the ΔV and ΔT measurement values will be displayed with divisions.

When the vertical mode is set to the ADD mode, and the CH1 and CH2 VOLTS/DIV controls are set to different scales, the ΔV measurement values will be displayed with divisions.

6. MAINTENANCE

The following instructions are executed by qualified personnel only. To avoid electrical shock, do not perform any servicing other than the operating instructions unless you are qualified to do so.

6-1. Fuse Replacement

If the fuse blows, the power lamp indicators will not light and the oscilloscope will not start. The fuse should not normally open unless a problem has developed in the unit. Try to determine and correct the cause of the blown fuse and replace only with a fuse of the correct rating and type on the rear panel.



WARNING. For continued fire protection. Replace fuse only with 250V fuse of the specified type and rating, and disconnect power cord before replacing fuse.

6-2. Line Voltage Conversion

The primary winding of the power transformer is tapped to permit operation from 100, 120, or 230VAC 50/60Hz line voltage. Conversion from one line voltage to another is done by changing the line voltage selector switch as shown in page 7. The rear panel identifies the line voltage to which the unit was factory set. To convert to a different line voltage, perform the following procedure:

- (1). Make sure the power cord is unplugged.
- (2). Adjust the line voltage selector switch to the desired line voltage position.
- (3). A change in line voltage may also require a corresponding change of fuse value. Install the correct fuse value as listed on rear panel.

6-3.Cleaning

To clean the oscilloscope, use a soft cloth dampened in a solution of mild detergent and water. Do not spray cleaner directly onto the oscilloscope because it may leak into the cabinet and cause damage.

Do not use chemicals containing benzene, toluene, xylene, acetone, or similar solvents. Do not use abrasive cleaners on any portion of the oscilloscope.

7.Block Diagram

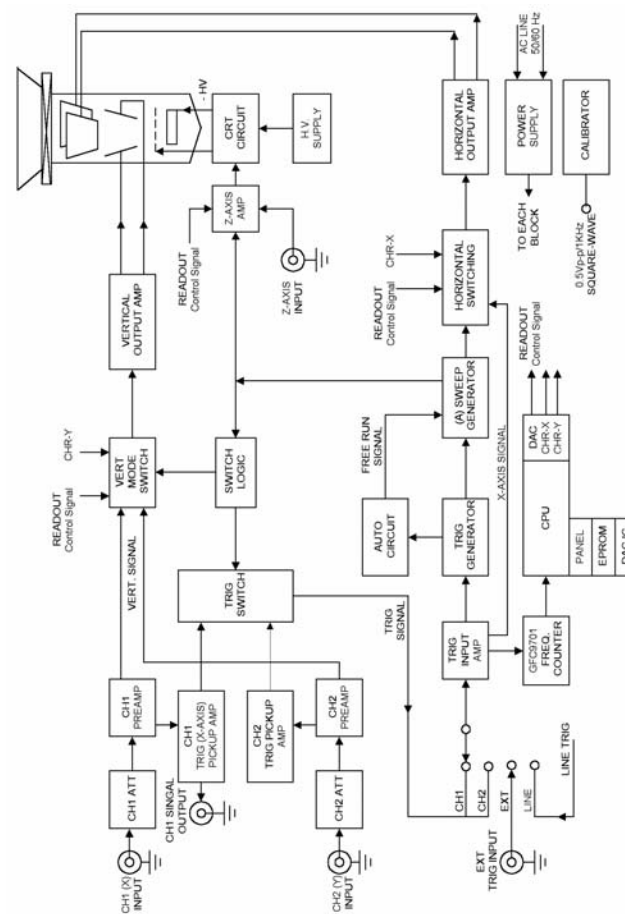

GOS-6051/6050/6031/6030 OSCILLOSCOPE

USER MANUAL
